

DAN TEC



DANTEC
HOSE COUPLINGS

INTRODUCTION

Dantec Ltd are well known as specialists in the field of fluid transfer. This brochure gives an outline of the hose couplings and adaptors which are available.

The range of products indicated does not show the whole range available, but covers the more common options. Other proprietary couplings and couplings for special purposes and to customer own design can be supplied.

Dantec Ltd carry extensive stocks of these couplings and can offer rapid deliveries at highly competitive prices.

All items are manufactured from high quality materials and pass our stringent quality control. All products are offered with Dantec's full warranty.

Because of our 25 years experience Dantec can provide unrivalled technical advice to ensure that customers are offered the best solutions to their fluid transfer problems.

As a hose manufacturer Dantec can complement their range of couplings with standard and custom made hoses for all conveyants.

Should you have any enquiries or technical queries please contact Dantec's technical sales or their authorised distributors and they will be able to offer a rapid response.

INDEX

Dantec Threaded Adaptors	1
Dantec Caps and Plugs	2
Dantec Threaded Hose Couplings	3
Dantec Camlocking Couplings	4
Dantec Todos	8
Dantec API Couplings and Adaptors	10
Dantec Steam and High Pressure Couplings	12
Dantec Flange Adaptors and Flange Hose Tails ..	14
Dantec Clamps, Clips and Ferrules	15
Dantec Quick Action Couplings	16

DANTEC THREADED ADAPTORS

Adaptors Lug and Hexagon in BSP, API, URT, V Thread.

Standard materials are Stainless Steel (316), Gun Metal (LG2) and Aluminium (LM25).

Other materials and grades available on request.

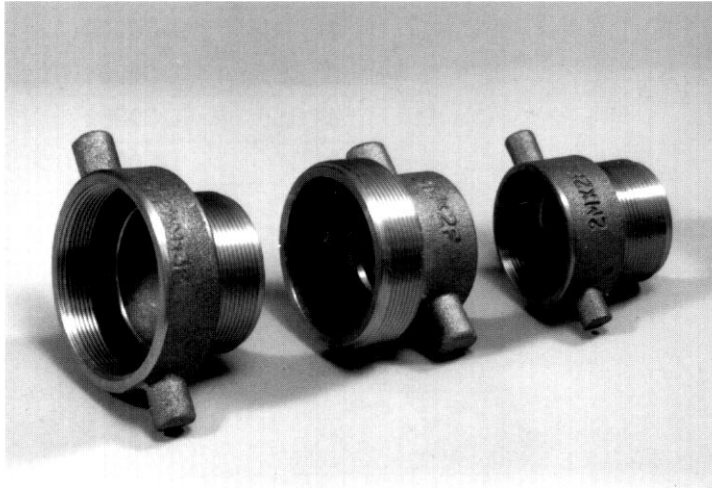

MALE	COMBINATION	F/MALE	CODE No.
1 1/2"	Reducing to	1 1/4"	D0001
1 1/2"	Changing to	1 1/2"	D0002
1 1/2"	Increasing to	2"	D0003
1 1/2"	Increasing to	2 1/2"	D0004
2"	Reducing to	1 1/4"	D0005
2"	Reducing to	1 1/2"	D0006
2"	Changing to	2"	D0007
2"	Increasing to	2 1/2"	D0008
2"	Increasing to	3"	D0009
2 1/2"	Reducing to	2"	D0010
2 1/2"	Changing to	2 1/2"	D0011
2 1/2"	Increasing to	3"	D0012
2 1/2"	Increasing to	4"	D0013
3"	Reducing to	2"	D0014
3"	Reducing to	2 1/2"	D0015
3"	Changing to	3"	D0016
3"	Increasing to	4"	D0017
4"	Reducing to	3"	D0018
4"	Changing to	4"	D0019



MALE TO MALE			
1 1/2"	Hex Matching	1 1/2"	D0020
1 1/2"	Matching	1 1/2"	D0021
2"	Reducing to	1 1/2"	D0022
2"	Matching	2"	D0023
2 1/2"	Reducing to	2"	D0024
2 1/2"	Matching	2 1/2"	D0025
3"	Reducing to	2"	D0026
3"	Reducing to	2 1/2"	D0027
3"	Matching	3"	D0028
4"	Reducing to	3"	D0029
4"	Matching	4"	D0030

For Stainless Steel prefix with code SS
 For Gun Metal prefix with code GM
 For Aluminium prefix with code AL

DANTEC CAPS AND PLUGS

Blanking Caps and Plugs available in standard thread forms BSP, API, URT, V-Thread etc. Standard Materials Stainless Steel (316). Gun Metal (LG2), Aluminium (LM25) and Polypropylene.



CAPS	SIZE	CODE No.
	1 1/2" BSP	DC0058
2" BSP	DC0059	
2 1/2" BSP	DC0060	
3" BSP	DC0061	
4" BSP	DC0062	
3" 'V'	DC0063	
4" 'V'	DC0064	
	3" URT	DC0065
	4" SRT	DC0066

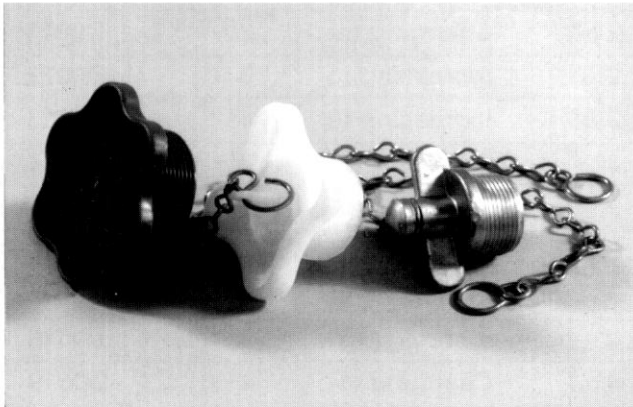

PLUGS	SIZE	CODE No.
	2" BSP	DP0067
2 1/2" BSP	DP0068	
3" BSP	DP0069	
4" BSP	DP0070	



PRESSURE CHECK CAP (Only available in Stainless Steel)	SIZE	CODE No.
	3"	PC0071

Dantec also offer a stainless steel pressure check cap in 3" size which can be used to ascertain if there is pressure in vessel or tank before unscrewing the cap. Thus providing greater safety in operation.

For Stainless Steel Adaptors prefix with code SS
 For Gun Metal Adaptors prefix with code GM
 For Aluminium Adaptors prefix with code AL

DANTEC THREADED HOSE COUPLINGS

Cap and Liner and Male in Lug Type and Hexagon. Thread Types BSP, API, URT, V-Thread etc. Standard material Stainless Steel (316), Gun Metal (LG2), Aluminium (LM25) and Polypropylene. Other materials and thread styles available on request.

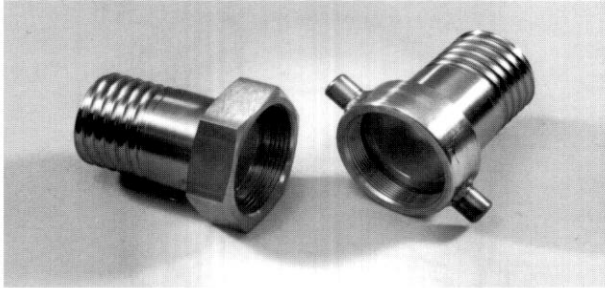

CAP AND LINER SERRATED TAIL FITTED WITH LEATHER WASHER	SIZE	CODE No.
	1 1/2"	CL0031
	2"	CL0032
	2 1/2"	CL0034
	3"	CL0035
4"	CL0036	
2" Cap x 1 1/2" Liner		



CAPS ONLY WITH LUGS	SIZE	CODE No.
	1 1/2" BSP	C0037
	2" BSP	C0038
	2 1/2" BSP	C0039
	3" BSP	C0040
	4" BSP	C0041
	3" 'V'	C0042
	4" 'V'	C0043
	3" URT	C0044
4" URT	C0045	



HOSE LINERS SERRATED TAIL	SIZE	CODE No.
	1 1/2"	L0046
	2"	L0047
	2 1/2"	L0048
	3"	L0049
	4"	L0050
4" 'V'	L0051	

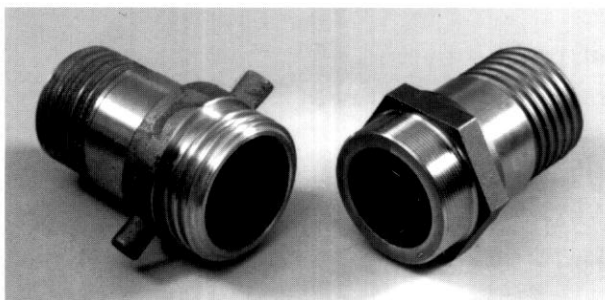

MALE COUPLERS SERRATED TAIL	SIZE	CODE No.
	1 1/2" BSP	MO052
	2" BSP	MO053
		MO054
	3" BSP	MO055
	4" BSP	MO056
	4" SRT	MO057

All the above are also available with spiral tails to suit composite hose.

For Stainless Steel prefix with code SS
 For Gun Metal prefix with code GM
 For Aluminium prefix with code AL
 For Polypropylene prefix with code PP

DANTEC CAMLOCKING COUPLINGS

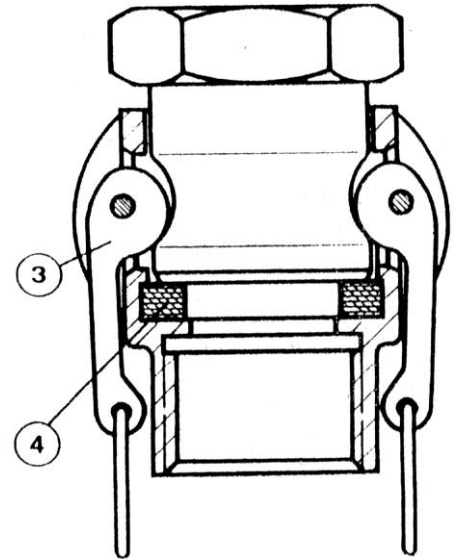
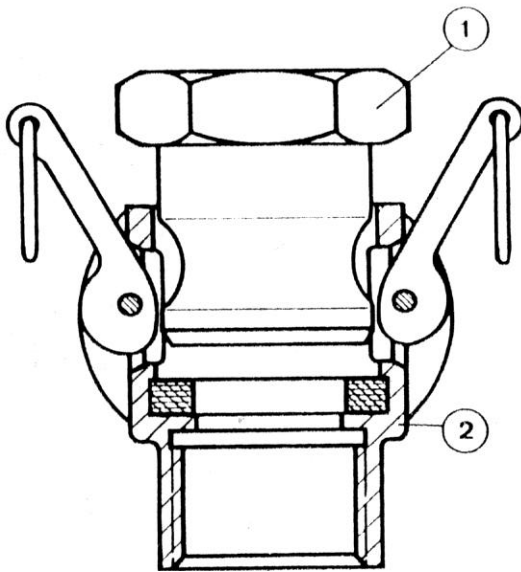

CHARACTERISTICS

You can be sure of a positive seal when you use DANTEC cam action couplings and adaptors.

INSTALLATION

Place the coupler (1) onto the adaptor and lower the arms. This action accurately positions the coupler because of the precision machined groove in the adaptor.

A seal is obtained by compression of the joint (4).

The arms and pins are of stainless steel, thus assuring a total protection against oxidization.

MATERIALS **BODY:** aluminium, bronze, stainless steel, polypropylene
 JOINT: Buna-N, E.P. rubber, viton, neoprene, PTFE, viton with PTFE envelope.

DIAMETER From 13 mm (1/2") to 200 mm (8") according to type.

ENDS Adaptors and couplings with male and female threads in BSP and NPT. Hose tails and welding parts.

USE Hydrocarbons, chemical products, food products, powders, paints, alcohols etc.

DANTEC CAMLOCKING COUPLINGS

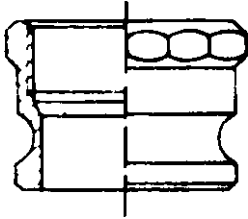

PART A

SIZE ϕ		ALUMINIUM	BRONZE	STAINLESS STEEL 316	POLYPROPYLENE
mm	"				
13	1/2	A050-A	A050-B	A050-SS	A050-P
19	3/4	A075-A	A075-B	A075-SS	A075-P
25	1	A100-A	A100-B	A100-SS	A100-P
30	1 1/4	A125-A	A125-B	A125-SS	A125-P
40	1 1/2	A150-A	A150-B	A150-SS	A150-P
50	2	A200-A	A200-B	A200-SS	A200-P
65	2 1/2	A250-A	A250-B	A250-SS	-
75	3	A300-A	A300-B	A300-SS	A300-P
100	4	A400-A	A400-B	A400-SS	-
125	5	A500-A	A500-B	A500-SS	-
150	6	A600-A	A600-B	A600-SS	-
200	8	A800-A	A800-B	-	-

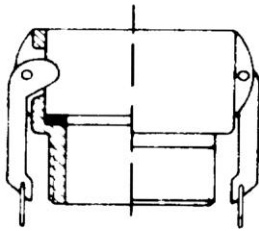

PART B

SIZE ϕ		ALUMINIUM	BRONZE	STAINLESS STEEL 316	POLYPROPYLENE
mm	"				
13	1/2	B050-A	B050-B	B050-SS	B050-P
19	3/4	B075-A	B075-B	B075-SS	B075-P
25	1	B100-A	B100-B	B100-SS	B100-P
30	1 1/4	B125-A	B125-B	B125-SS	B125-P
40	1 1/2	B150-A	B150-B	B150-SS	B150-P
50	2	B200-A	B200-B	B200-SS	B200-P
65	2 1/2	B250-A	B250-B	B250-SS	-
75	3	B300-A	B300-B	B300-SS	B300-P
100	4	B400-A	B400-B	B400-SS	-
125	5	B500-A	B500-B	B500-SS	-
150	6	B600-A	B600-B	B600-SS	-
200	8	-	-	-	-

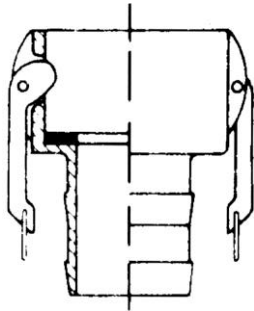

PART C

SIZE ϕ		ALUMINIUM	BRONZE	STAINLESS STEEL 316	POLYPROPYLENE
mm	"				
13	1/2	C050-A	C050-B	C050-SS	C050-P
19	3/4	C075-A	C075-B	C075-SS	C075-P
25	1	C100-A	C100-B	C100-SS	C100-P
30	1 1/4	C125-A	C125-B	C125-SS	C125-P
40	1 1/2	C150-A	C150-B	C150-SS	C150-P
50	2	C200-A	C200-B	C200-SS	C200-P
65	2 1/2	C250-A	C250-B	C250-SS	-
75	3	C300-A	C300-B	C300-SS	C300-P
100	4	C400-A	C400-B	C400-SS	C400-P
125	5	C500-A	C500-B	C500-SS	-
150	6	C600-A	C600-B	C600-SS	-
ZUU	8	-	-	-	-

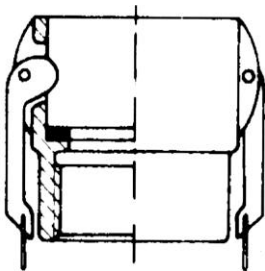

PART D

SIZE ϕ		ALUMINIUM	BRONZE	STAINLESS STEEL 316	POLYPROPYLENE
mm	"				
13	1/2	D050-A	D050-B	D050-SS	D050-P
19	3/4	D075-A	D075-B	D075-SS	D075-P
25	1	D100-A	D100-B	D100-SS	D100-P
30	1 1/4	D125-A	D125-B	D125-SS	D125-P
40	1 1/2	D150-A	D150-B	D150-SS	D150-P
50	2	D200-A	D200-B	D200-SS	D200-P
65	2 1/2	D250-A	D250-B	D250-SS	-
75	3	D300-A	D300-B	D300-SS	D300-P
100	4	D400-A	D400-B	D400-SS	-
125	5	D500-A	D500-B	D500-SS	-
150	6	D600-A	D600-B	D600-SS	-
200	8	D800-A	D800-B	-	-

DANTEC CAMLOCKING COUPLINGS

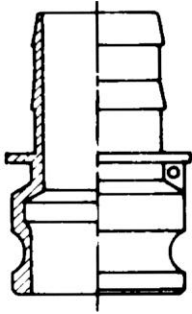

PART E

SIZE ϕ		ALUMINIUM	BRONZE	STAINLESS STEEL 316	POLYPROPYLENE
mm	"				
13	1/2	E050-A	E050-B	E050-SS	E050-P
19	3/4	E075-A	E075-B	E075-SS	E075-P
25	1	E100-A	E100-B	E100-SS	E100-P
30	1 1/4	E125-A	E125-B	E125-SS	E125-P
40	1 1/2	E150-A	E150-B	E150-SS	E150-P
50	2	E200-A	E200-B	E200-SS	E200-P
65	2 1/2	E250-A	E250-B	E250-SS	-
75	3	E300-A	E300-B	E300-SS	E300-P
100	4	E400-A	E400-B	E400-SS	E400-P
125	5	E500-A	E500-B	E500-SS	-
150	6	E600-A	E600-B	E600-SS	-
200	8	-	-	-	-

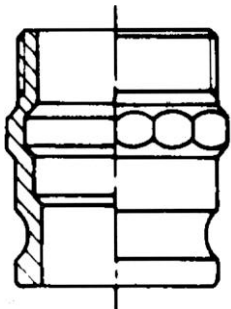

PART F

SIZE ϕ		ALUMINIUM	BRONZE	STAINLESS STEEL 316	POLYPROPYLENE
mm	"				
13	1/2	F050-A	F050-B	F050-SS	F050-P
19	3/4	F075-A	F075-B	F075-SS	F075-P
25	1	F100-A	F100-B	F100-SS	F100-P
30	1 1/4	F125-A	F125-B	F125-SS	F125-P
40	1 1/2	F150-A	F150-B	F150-SS	F150-P
50	2	F200-A	F200-B	F200-SS	F200-P
65	2 1/2	F250-A	F250-B	F250-SS	-
75	3	F300-A	F300-B	F300-SS	F300-P
100	4	F400-A	F400-B	F400-SS	-
125	5	F500-A	F500-B	F500-SS	-
150	6	F600-A	F600-B	F600-SS	-
200	8	-	-	-	-

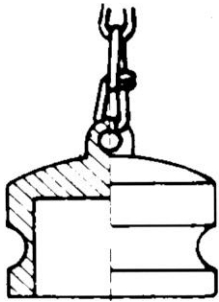

PART DP

SIZE ϕ		ALUMINIUM	BRONZE	STAINLESS STEEL 316	POLYPROPYLENE
mm	"				
13	1/2	DP050-A	DP050-B	DP050-SS	DP050-P
19	3/4	DP075-A	DP075-B	DP075-SS	DP075-P
25	1	DP100-A	DP100-B	DP100-SS	DP100-P
30	1 1/4	DP125-A	DP125-B	DP125-SS	DP125-P
40	1 1/2	DP150-A	DP150-B	DP150-SS	DP150-P
50	2	DP200-A	DP200-B	DP200-SS	DP200-P
65	2 1/2	DP250-A	DP250-B	DP250-SS	-
75	3	DP300-A	DP300-B	DP300-SS	DP300-P
100	4	DP400-A	DP400-B	DP400-SS	DP400-P
125	5	DP500-A	DP500-B	DP500-SS	-
150	6	DP600-A	DP600-B	DP600-SS	-
200	8	-	-	-	-

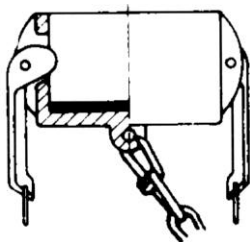

PART DC

SIZE ϕ		ALUMINIUM	BRONZE	STAINLESS STEEL 316	POLYPROPYLENE
mm	"				
13	1/2	DC050-A	DC050-B	DC050-SS	DC050-P
19	3/4	DC075-A	DC075-B	DC075-SS	DC075-P
25	1	DC100-A	DC100-B	DC100-SS	DC100-P
30	1 1/4	DC125-A	DC125-B	DC125-SS	DC125-P
40	1 1/2	DC150-A	DC150-B	DC150-SS	DC150-P
50	2	DC200-A	DC200-B	DC200-SS	DC200-P
65	2 1/2	DC250-A	DC250-B	DC250-SS	-
75	3	DC300-A	DC300-B	DC300-SS	DC300-P
100	4	DC400-A	DC400-B	DC400-SS	DC400-P
125	5	DC500-A	DC500-B	DC500-SS	-
150	6	DC600-A	DC600-B	DC600-SS	-
200	8	DC800-A	DC800-B	-	-

DANTEC CAMLOCKING COUPLINGS

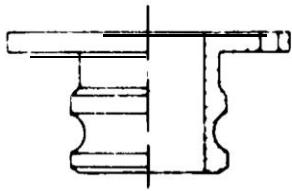

PART FLA

SIZE ϕ		ALUMINIUM	BRONZE	STAINLESS STEEL 316	POLYPROPYLENE
mm	"				
13	1/2	-	-	-	-
19	3/4	FLA075-A	FLA075-B	FLA075-SS	-
25	1	FLA100-A	FLA100-B	FLA100-SS	-
30	1 1/4	FLA125-A	FLA125-B	FLA125-SS	-
40	1 1/2	FLA150-A	FLA150-B	FLA150-SS	-
50	2	FLA200-A	FLA200-B	FLA200-SS	-
65	2 1/2	FLA250-A	FLA250-B	FLA250-SS	-
75	3	FLA300-A	FLA300-B	FLA300-SS	-
100	4	FLA400-A	FLA400-B	FLA400-SS	-
125	5	-	-	-	-
150	6	FLA600-A	FLA600-B	-	-
200	8	FLA800-A	FLA800-B	-	-

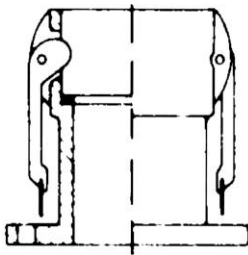

PART FLB

SIZE ϕ		ALUMINIUM	BRONZE	STAINLESS STEEL 316	POLYPROPYLENE
mm	"				
13	1/2	-	-	-	-
19	3/4	FLB075-A	FLB075-B	FLB075-SS	-
25	1	FLB100-A	FLB100-B	FLB100-SS	-
30	1 1/4	FLB125-A	FLB125-B	FLB125-SS	-
40	1 1/2	FLB150-A	FLB150-B	FLB150-SS	-
50	2	FLB200-A	FLB200-B	FLB200-SS	-
65	2 1/2	FLB250-A	FLB250-B	FLB250-SS	-
75	3	FLB300-A	FLB300-B	FLB300-SS	-
100	4	FLB400-A	FLB400-B	FLB400-SS	-
125	5	-	-	-	-
150	6	FLB600-A	FLB600-B	FLB600-SS	-
200	8	FLBLB800-A	FLBLB800-B	-	-

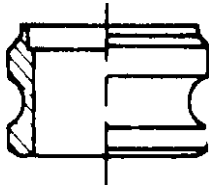

PART AW

SIZE ϕ		ALUMINIUM	BRONZE	STAINLESS STEEL 316	POLYPROPYLENE
mm	"				
13	1/2	-	-	-	-
19	3/4	-	-	-	-
25	1	AW100-A	AW100-B	AW100-SS	-
30	1 1/4	-	-	AW125-SS	-
40	1 1/2	AW150-A	AW150-B	AW150-SS	-
50	2	AW200-A	AW200-B	AW200-SS	-
65	2 1/2	AW250-A	AW250-B	AW250-SS	-
75	3	AW300-A	AW300-B	AW300-SS	-
100	4	AW400-A	AW400-B	AW400-SS	-
125	5	AW500-A	AW500-B	AW500-SS	-
150	6	AW600-A	AW600-B	AW600-SS	-
200	8	-	-	-	-

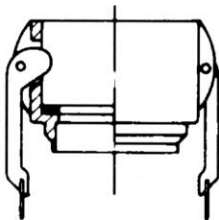

PART DW

SIZE ϕ		ALUMINIUM	BRONZE	STAINLESS STEEL 316	POLYPROPYLENE
mm	"				
19	3/4	-	-	-	-
25	1	DW100-A	DW100-B	DW100-SS	-
30	1 1/4	-	-	DW125-SS	-
40	1 1/2	DW150-A	DW150-B	DW150-SS	-
50	2	DW200-A	DW200-B	DW200-SS	-
65	2 1/2	DW250-A	DW250-B	DW250-SS	-
75	3	DW300-A	DW300-B	DW300-SS	-
100	4	DW400-A	DW400-B	DW400-SS	-
125	5	DW500-A	DW500-B	DW500-SS	-
150	6	DW600-A	DW600-B	DW600-SS	-
200	8	-	-	-	-



todomatic®

DESIGN Our TODO-MATIC coupling is designed for spill free connection and disconnection. Both the coupler and adapter contain a piston valve which opens when the units are mated and closes when the units are disconnected, this ensures containment of the media. Coupler and adapter valves can only be opened when connected to each other. The flow of the products is activated with the mating of the two parts. This is accomplished with a 100 degree twist, which locks them in place and opens both piston valves.

CONSTRUCTION The TODO-MATIC couplers and adapters are available in aluminium, brass/gunmetal and stainless steel. The standard FPM (Viton) seal is complemented by the availability of EPDM, fluorsilicone, perfluorelastomer and others. We are in a position to offer a coupling to meet most of the liquid handling needs of industry.

APPLICATIONS TODO-MATIC couplings are in use throughout the petroleum industry, in transportation, marine operations, tank farms and in-plant applications. The chemical and pharmaceutical industries have also found the TODO ideal for many of their operations. It is a safe fluid handling coupling for environmentally and cost conscious uses.

SIZE RANGE The TODO-MATIC is available in sizes from 3/4" to 6" with NPT, BSP and NPSF threads. The tankunits/adaptors are also available in flanged units.

CERTIFICATIONS TODO-MATIC couplings are used world wide, and have received the approval of many, such as TÜV (The German Technical Control Board), Shell, Air BP, ADR (Bureau Veritas), British Rail etc.



3" Aluminium coupler, connecting socket ø 105 mm.

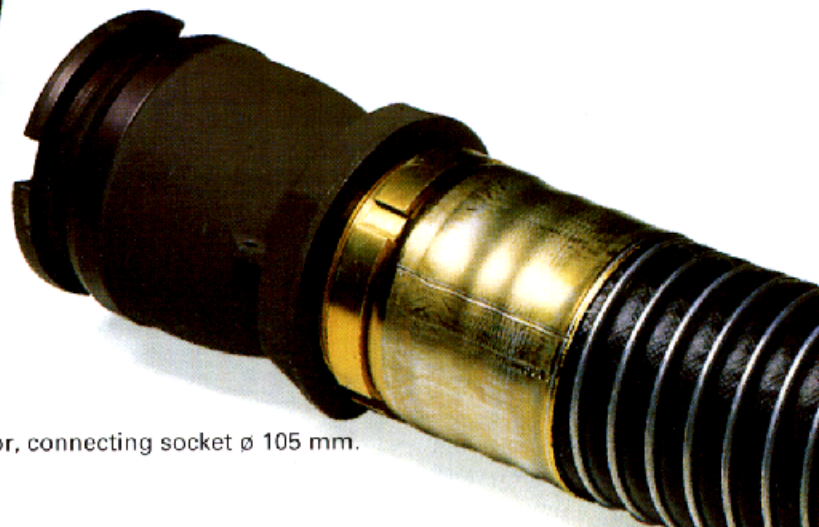

3" Aluminium adaptor, connecting socket ø 105 mm.

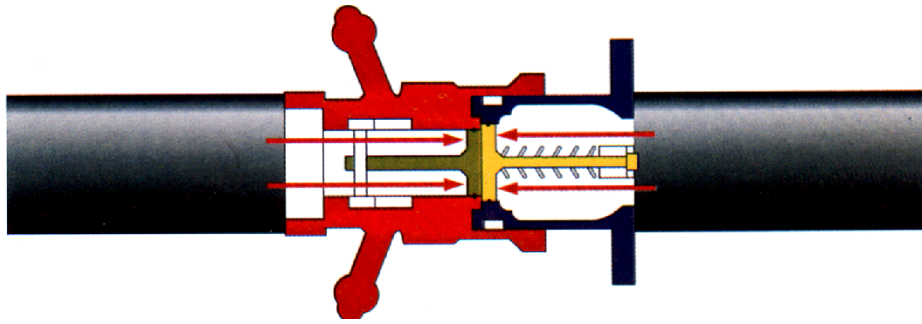

Turning the coupler and adapter 15 degrees clockwise locks them together, keeping the piston valves closed in this position. The valves are opened when the unit is turned further to 100 degrees, and in turn closed when a similar turn is made counter-clockwise. All flow is stopped and a disconnection can be made.

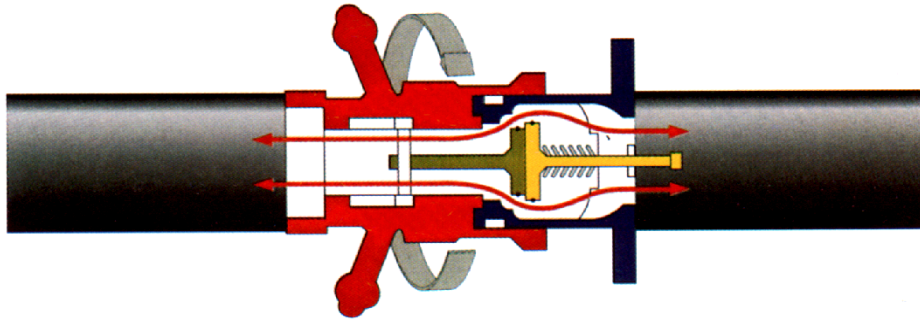

BENEFITS

- **ECONOMICAL** - No loss or spillage of liquids at connection or disconnection.
- **TIME SAVING** - No need to drain hoses or pipe system.
- **SAFETY** Coupling cannot be opened without being connected to one another.
- **ENVIRONMENTALLY PROTECTIVE** -Accidental spillage eliminated.
- **EASE OF HANDLING** - Opens and closes in one easy movement. All couplers have swivel connections.
- **PRODUCTS** - The most diversified product line available in the market.

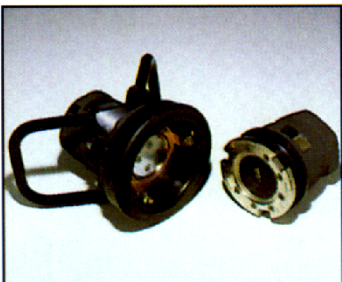

4" (socket 164 mm).
Used worldwide for offshore applications, rail tankers and for jet fuel handling.



2.1/2" 3" (socket 105 mm).
Our most popular coupling, used for all kinds of applications, Standard for jet fuel handling.



1.1/2"-2" (socket 70 mm).
For pipes and hoses 1.1/2"-2". Often used for applications in chemical plants.



3/4" - 1.1/2" (socket 56 mm)
Our smallest coupling, perfect for smaller hose and pipe dimensions.



DANTEC API COUPLINGS AND ADAPTORS

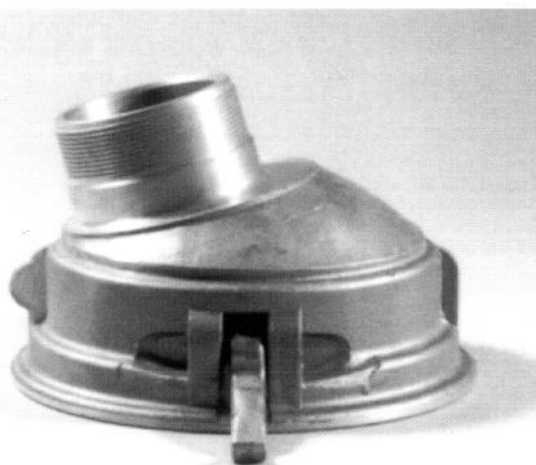

The API regime for handling of petrol and diesel products is rapidly becoming the standard format not just in the U.K. but also in an increasing number of countries worldwide.

The advantage of a genuinely interchangeable system for safe fast bottom loading of petroleum products with the added benefit of protection of the environment against ozone depleting vapour loss cannot be disregarded. Dantec therefore offer a complete range of API bottom loading adaptors,



DANTEC API COUPLINGS AND ADAPTORS

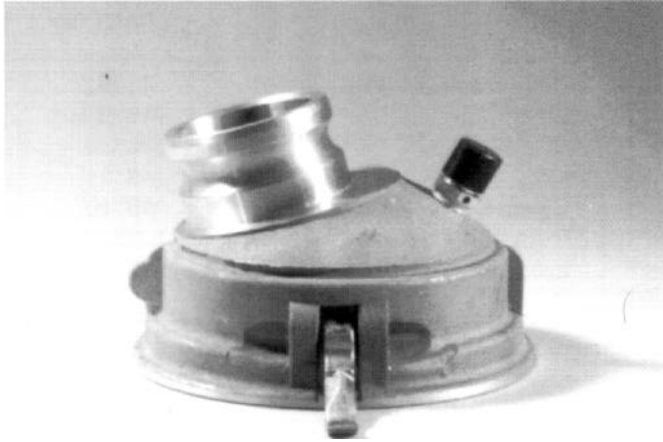

loading valves, vapour return couplings for road tanker and hose connections. (Obviously complemented by Dantec's own Danoil product and vapour return hoses.) A small number of the options is illustrated including adaptors with built in sight glasses and pressure relief valves. Material is generally aluminium but modification in stainless steel or gun metal are possible.

For advice on particular applications and options do not hesitate to contact us.

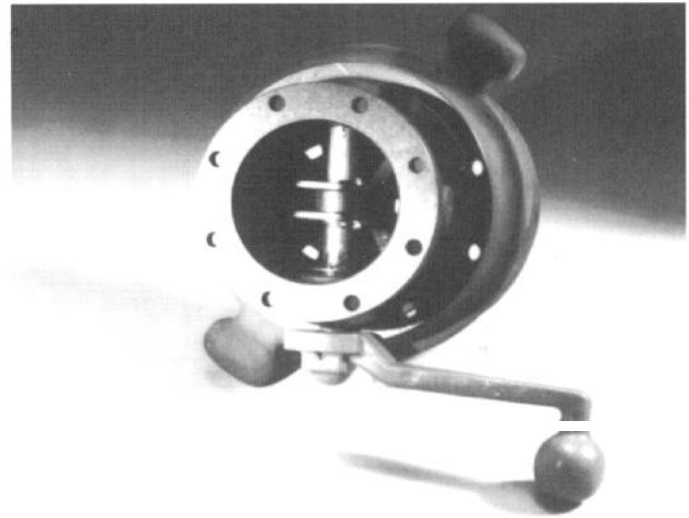

DANTEC STEAM AND HIGH PRESSURE COUPLINGS

STYLE 'MS'

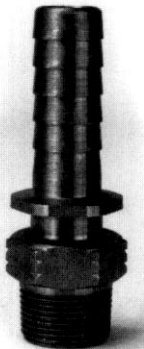

MALE COUPLING (without Clamps)

HOSE I.D.		THREAD		DESCRIPTION	COUPLING PART No
ins	mm	Specify when ordering			
1/2"	13	1/2"	BSP or NPT	Male Stem (without clamp)	MS50
3/4"	19	3/4"	BSP or NPT	" " " "	MS75
1"	25	1"	BSP or NPT	" " " "	MS100
1 1/4"	32	1 1/4"	BSP or NPT	" " " "	MS125
1 1/2"	38	1 1/2"	BSP or NPT	Select Correct Clamp Pt. No.	MS150
2"	50	2"	BSP or NPT	from Table Below	MS200
2 1/2"	65	2 1/2"	- NPT	according to Hose O.D. Size	MS250
3"	75	3"	- NPT		MS300

GROUND JOINT FEMALE ASSEMBLY (without Clamps)

HOSE I.D.		THREAD		DESCRIPTION	COUPLING PART No
ins	mm	Specify when ordering			
1/2"	13	1/2"	BSP or NPT	Female Assy (without clamp)	GJ50
3/4"	19	3/4"	BSP or NPT	" " " "	GJ75
3/4"	19	1"	BSP or NPT	" " " "	GJ100 x 75*
1"	25	1"	BSP or NPT	" " " "	GJ100
1"	25	3/4"	BSP or NPT	Select Correct Clamp Pt. No.	GJ75 x 100*
1	32	1 1/4"	BSP or NPT	from Table Below	GJ125
1 1/4"	32	1 1/2"	BSP or NPT	according to Hose O.D. Size	GJ150 x 125
1	38	1 1/2"	BSP or NPT	" " " "	GJ150
1 1/2"	38	1 1/4"	BSP or NPT	" " " "	GJ125x 150
2"	50	2"	BSP or NPT	" " " "	GJ200
2 1/2"	65	2 1/2"	- NPT	" " " "	GJ250
3	75	3"	NPT	" " " "	GJ300

WASHER TYPE-Substitute 'GJ' with 'WT' in above Part No. Listing

STYLE 'GJ'

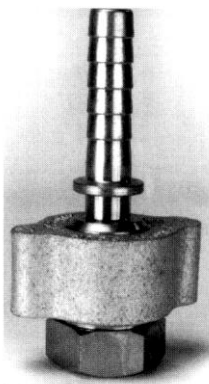

'HPC' CLAMPS

for use with STYLE "MS", "GJ", "HPM" and "FX"

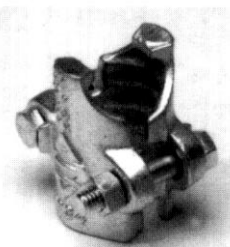

2 BOLT CLAMP

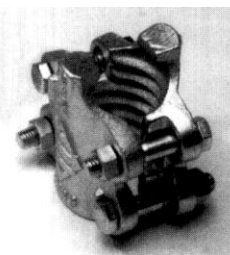

4 BOLT CLAMP

HOSE I.D.		HOSE O.D. SIZE RANGE		UNC BOLTS		CLAMP PART No.
ins	mm	ins	mm	SIZE	QTY	
		Min - Max	Min - Max			
1/2"	13	27/32" - 31/32"	21 - 25	1/4" x 1 1/2" S	2	HPC1
1/2"	13	1 - 1 1/8"	25 - 29	5/16" x 1 1/2" B	2	HPC2
1/2"	13	1 1/8" - 1 7/32"	29 - 31	1/16" x 1 3/4" B	2	HPC3
3/4"	19	1 7/32" - 1 11/32"	31 - 34	3/8" x 2 B	2	HPC4
3/4"	19	1 11/32" - 1 15/32"	34 - 37	3/8" x 2" B	2	HPC5
3/4"	19	1 15/32" - 1 19/32"	37 - 40	3/8" x 2" B	2	HPC6
1	25	1 13/32" - 1 17/32"	36 - 39	3/8" x 2" B	2	HPC7
1	25	1 17/32" - 1 21/32"	39 - 42	3/8" x 2 1/4" B	4	HPC8
1	25	1 21/32" - 1 25/32"	42 - 45	3/8" x 2 1/4" S	4	HPC9
1	25	1 25/32" - 1 29/32"	45 - 48	3/8" x 2 1/4" S	4	HPC10
1	25	1 29/32" - 2 1/32"	48 - 52	3/8" x 2 1/2" S	4	HPC11
1 1/4"	32	1 7/8" - 2 1/16"	48 - 52	7/16" x 2 1/2" B	4	HPC12
1 1/4"	32	2 1/16" - 2 1/4"	52 - 57	7/16" x 2 1/2" S	4	HPC13
1 1/4"	32	2 3/16" - 2 5/16"	56 - 59	7/16" x 2 1/2" S	4	HPC14
1 1/2"	38	2 - 2 3/16"	51 - 56	7/16" x 2 3/4" B	4	HPC15
1 1/2"	38	2 3/16" - 2 3/8"	56 - 60	7/16" x 2 1/2" B	4	HPC16
1 1/2"	38	2 15/32" - 2 23/32"	63 - 69	7/16" x 2 1/2" B	4	HPC17/18
2	50	2 3/8" - 2 9/16"	60 - 65	1/2" x 2 3/4" B	4	HPC19
2	50	2 9/16" - 2 3/4"	65 - 70	1/2" x 2 3/4" S	4	HPC20
2	50	2 3/4" - 3 1/16"	70 - 78	1/2" x 3 1/4" B	4	HPC21
2	50	3 1/8" - 3 1/16"	79 - 87	1/2" x 3 1/4" B	4	HPC21
2 1/2"	65	3 1/2" - 3 5/16"	89 - 100	5/8" x 3 1/2" B	4	HPC23/24
3	75	3 13/16" - 4 3/16"	97 - 106	5/8" x 3 1/2" S	4	HPC25/26
3	75	4 1/16" - 4 7/16"	103 - 113	3/4" x 4" S	4	HPC27

HPC CLAMPS can also be used with the following DANTEC Coupling Types "UNIVERSAL" "SAFELOC" "QUICKLOCK" "MODY-LOC" and others with suitable collar

DANTEC STEAM AND HIGH PRESSURE COUPLINGS

'SERIES' COUPLINGS

COMPONENT PARTS (Female Assemblies only)

"MS" male stems and "HPC" Clamps see opposite page

Hose I.D. or Thread Size ins mm	GJ Ground Joint			WT Washer Type			
	GJ Hose Stem	Swivel Nut	GJ Female Spud	WT Hose Stem	Swivel Nut	Washer	WT Female Spud
1/2" 13	GJS 50	SN 2	GJFS 50	WTS 50	SN 2	W50	WTFS 50
1/4" 19	GJS 75	SN 7	GJFS 75	WTS 75	SN 7	W75	WTFS 75
1" 25	GJS 100	SN 7	GJFS 100	WTS 100	SN 7	W75	WTFS 100
1 1/4" 32	GJS 125	SN 17	GJFS 125	WTS 125	SN 17	W125	WTFS 125
1" 38	GJS 150	SN 17	GJFS 150	wrs 150	SN 17	W125	WTFS 150
2" 50	GJS 200	SN 27	GJFS 200	WTS 200	SN 27	W200	WTFS 200
2 1/2" 65	GJS 250	SN 41	GJFS 250				
3" 75	GJS 300	SN 45	GJFS 300				

NOT AVAILABLE IN LARGER SIZES

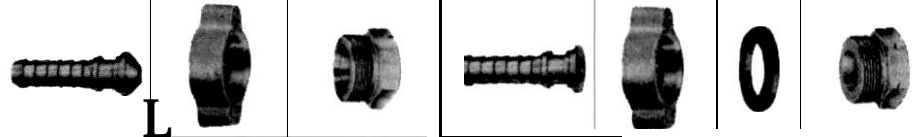

To provide "MALE SPUD" use Female Spud v adaptor".

a "barrel nipple" or "Male x Male

"DOUBLE SPUD" use 2 Female Spuds back-to-back using a "barrel nipple" or "Male x Male adaptor"

STYLE 'HPM'



HIGH PRESSURE HOSE MENDERS/JOINERS WITH COLLAR

Produced with two annular security collars specifically designed for use with HPC Clamps, for high pressure applications.

HPC Clamps should be fitted at 90° to one another

Size	1/2"	3/4"	1"	1 1/4"	1 1/2"	2"
	13mm	19mm	25mm	32mm	38mm	50mm
Part No.	HPM 50	HPM 75	HPM 100	HPM 125	HPM 150	HPM 200

STYLE 'FX'

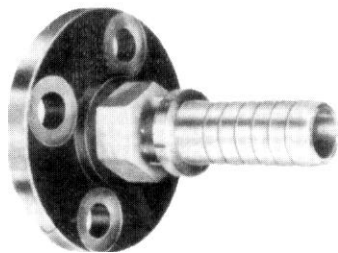

FLANGED HOSE SPIGOTS WITH COLLAR FOR USE WITH HPC CLAMPS

For Hose applications where a Flanged Hose Spigot is required with the security of HPC SAFETY CLAMPS.

SCREWED TYPE is fabricated using standard 'MS' Male Stem and threaded to flange using P.T.F.E. Tape or 'Loctite' for efficient thread sealing.

WELDED TYPE uses swaged steel hose stems with an annular security collar designed for use with HPC Clamps and welded to slip-on flange.

Supplied Black finish as standard.

Size Ins mm	B.S. 10 Screwed Type	A.S.A. 150 Screwed Type	D.I.N.	Other Specifications
3/4" 19	FXHS 75xD	FXHS 75x150	Use Similar Part No. Size make up as for B.S. or A.S.A. flanges but substitute D.I.N. Specifications	Use Similar Part No. System B.S. Flanges substitute E for D or F, N, J etc. A.S.A. Flanges substitute 300 for 150 etc. D.I.N. Flanges substitute D.I.N. Spec. No.
1" 25	FXHS 100xD	FX HS 100 x 150		
1 1/4" 32	FXHS 125xD	FX HS 126 x 150		
1 1/2" 36	FXHS 150xD	FX HS 150 x 150		
2" 50	FXHS 200xD	FX HS 200 x 150		
2 1/2" 65	FXHS 250xD	FX HS 250 x 150		
3" 75	FX HS 300x D	FX HS 300 x 150		
4" 100	FXHS 400xD	FX HS 400 x 150		

For Welded Type suffix Pt. No. /W

DANTEC FLANGE ADAPTORS AND FLANGE HOSE TAILS

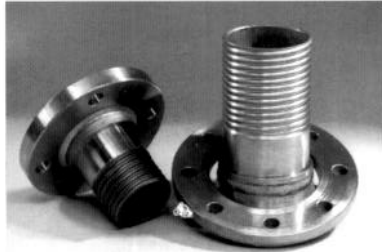

Dantec offer a wide variety of combinations of flanged hose couplings with serrated or ribbed tails for rubber and PVC hose or spiral tails to suit composite hose. Also available are flange to thread or flange to flange adapters. Common materials are stainless steel, carbon steel, gun metal, aluminium or polypropylene. However, other materials are available on request. Configurations for flanges include either fixed or swivel and ANSI, DIN, BST or any other combination. Dantec use only the highest quality components of reputable origin.

DANTEC JOINTS AND SEALS



Dantec as one of the country's leading manufacturers of gaskets can offer washers, flange gaskets and lid seals at highly competitive prices. Stocked materials include CAF, asbestos free jointings, leather, all grades of rubber, felt, polypropylene cork, PTFE, Gylon and Goretex. PTFE envelopes to suit the above gaskets are available from stock.

DANTEC STRAPS, CHAINS AND TIES



Dantec carry a comprehensive range of straps, wires, chains and ties. Please enquire for information.

DANTEC CLAMPS, CLIPS AND FERRULES

Wherever a hose coupling is mounted an effective method of securing the particular coupling is essential to facilitate this. Dantec offer a full range of clamps, clips and ferrules.

DANTEC WORM DRIVE CLIPS

The simple solution for low pressure applications available in plated steel and stainless steel (non magnetic grades available)

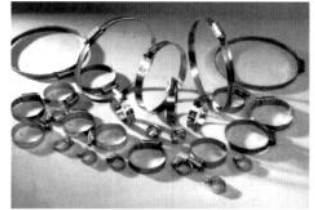

DANTEC DOUBLE BOLT CLAMPS (DBC)

For medium pressures and thick hose walls. These clamps are available in a wide range of sizes to suit all diameters from 17mm - 225mm.

Available as standard in galvanised malleable iron (stainless steel to special order).

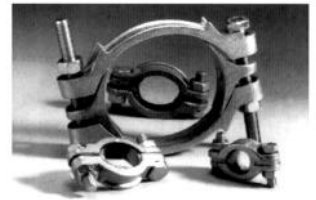

DANTEC FINGER CLAMPS (HPC AND UC)

For medium to high pressures, such as high pressure air/steam. These clamps have added security by virtue of the fingers which lock into the mating groove on the hose tail. HPC are the recognised coupling method for safe attachment of steam hose couplings. Available in galvanised malleable iron (stainless steel available to order).



DANTEC 'O' CLIPS

Simple quick and cheap solution for low pressures and small bore sizes. Available in stainless steel and galvanised mild steel.



DANTEC 'BAND-IT' STRAPPING

Separate bands and buckles in stainless steel for low to medium pressures. A cheap effective solution. Requires the use of a special tightening tool. (Also available from Dantec).



DANTEC SHELL CLAMPS

Similar in operation to the finger clamps but relying on a full ring to grip the groove on the hose tail rather than fingers. A very positive attachment.



DANTEC QUICK ACTION COUPLINGS

In addition to the Camlock and Todo Couplings already described, Dantec offer a comprehensive range of quick acting couplings for air, water, steam, oil and chemical applications. Some of the more popular of these items are described below:

SNAPTITE

Available in carbon steel, brass or stainless steel.

Sizes: 1/4" - 4"



HANSEN

Available in carbon steel, brass or stainless steel.

Sizes: 1/8" - 3"



UNICONE

Available in carbon steel, stainless steel or aluminium.

2" Sizes: 3" AND 4"



SCHRADER

Available in plated carbon steel.

Sizes: 1/8" - 3/4"



BAUER

Available in galvanised mild steel and stainless steel.

Sizes: 2" 8"



DANTEC QUICK ACTION COUPLINGS

UNIVERSAL

Available in plated malleable iron.

Sizes: 3/8" - 1"

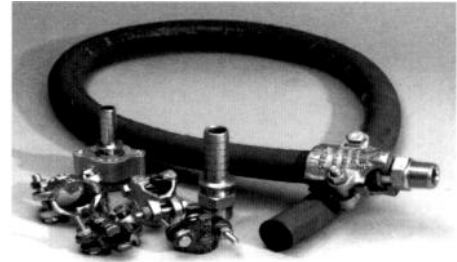

QUICK RELEASE COMPRESSOR COUPLINGS (QR)

Available in plated malleable iron.

Sizes: 3/8" - 1"



STORZ

Available in aluminium, stainless steel, brass.

Sizes: Males 1" - 4"
Females 1/2" - 8"



GUILLEMIN (SYMMETRIQUE)

Available in aluminium, stainless steel, brass.

Sizes: 1/2" - 6"



TANKWAGON (TW)

Available in aluminium, stainless steel, brass.

Sizes: 2", 3", 4"



Head Office and Works:
DANTEC LTD
TARRAN WAY
TARRAN INDUSTRIAL ESTATE
MORETON
WIRRAL CH46 4TL

Tel: 0151 678 2222
Fax: 0151 606 0188



West Midlands:
DANTEC LTD
UNIT 4
WATTVILLE ROAD
WARLEY
SMETHWICK
WEST MIDLANDS B66 2NT
Tel 0121 565 5717
Fax: 0121 555 5313